



## BigDaddy's Scent Elimination Spray Recipe

### Message and Disclaimers:

*Please review all aspects of your project and before you begin, determine all aspects of your finished project. Examples of this would be such things as mounting diameters - for instance to a tree with unknown sizes may be different than mounting it on a telephone pole or object of a known size? Are you going to be building your project out of wood, composites, steel or aluminum etc. - be aware that some dimensions may require adjustments as determined by the type and use of certain materials;*

*Remember you may choose to build with materials you have lying around the house, your barn or shop. As an example, when it comes to strength different sizes, varying dimensions, product weights and thickness may vary widely. Some other examples that come to mind might be in using materials such as angle steel vs. tube steel or u-channel vs. wood or other materials.*

*Other examples that you should pre-determine for your particular project would be the size, weight bearing and load capacities - FOR EXAMPLE - The Structural Integrity required for a safe and durable project - i.e., if you weigh 316 lbs vs. 155 lbs what changes may need to be addressed.*

***Big-Daddy's Bottom Line - THINK BEFORE YOU START!*** *It is of the utmost importance that you completely review all specifications and adapt them to your desired project for optimum results and satisfaction. We assume no liability whatsoever - Verification and acceptance of all measurements as outlined are the final responsibility of the fabricator (that's You! ) We assume no liability for the use or misuse of any plan, products or materials utilized, or any other aspects or outlines as may be provided here with. This item is provided for your personal use only and not for resale or distribution without prior written consent.*

## Disclaimers and Other Legal Stuff

*HuntUSA.org®, HuntSports.com®, TheNationalHuntingConsortium®, ThePolak®, WeFixItUSA.com®, eSeekGod.com®, iAskGod.com®, it's owners, operators, nor any of our other world wide web venues, retailers, subsidiaries, suppliers, vendors, manufacturers, non-profits, members or any associates whatsoever, assumes any responsibility or liability, express or implied, for the use of, or misuse of, any product either bought, sold, listed, offered, or shown herein or offered thru any other sales or marketing web-site or venue. All City, County, State, and Federal Laws and Ordinances must be strictly adhered to and are the sole responsibility of the buyer. We make no warranties, expressed or implied, other than those as stated by the manufacturer. No information provided by us or sold by us shall be rented, sold, or given away to any third party business or individual without the copyright owner permissions. We will never willfully disclose any information about our site visitors without first receiving the visitor's permission to do so. Any Do-It-Yourself, or Handyman Guides are designed to help you and there are no warranties, either express or implied and your results will differ from others, based on knowledge and skill levels. The fundamental concept of this information provided herewith is that you read, study and possibly utilize this product as a "starting point" for going forward with planning your project; If you need to perform independent research, then do so and judge for yourself the merits of the material that has been provided herewith.*

**BigDaddy@HuntSports.com** recommends and endorses specific ideas, concepts and opportunities and cannot be liable for same. You should carefully consider whether our plans, ideas, concepts, How To and DIY programs or information is appropriate for you personally, in light of your experience, objectives, financial resources and other personal circumstances. The websites and all information technology and information provided herein are for guidance and information purposes only and their content for products and services offered are not intended to provide investment, tax, business development or other legal advice. The information contained herein has been compiled from sources deemed reliable and accurate to the best of our knowledge. However, we cannot guarantee the accuracy, completeness and cannot be held liable for any errors or omissions. Changes may be made periodically and at any time. We herewith deny any responsibility to update any previously purchased PDF's or copies of CD's etc.

All information contained herein should be independently verified and confirmed by appropriate sources and we do not accept any liability for any loss or damages whatsoever and the reader, or user, herewith agrees to indemnify and hold us harmless for any damages, costs or expenses, including any legal fees, potentially resulting from the application of any of the information provided herewith. This disclaimer applies to any damages or injury caused by any failure of performance, error, omission, interruption, deletion, defect, delay in operation or transmission, computer virus, communication line failure, theft or destruction or unauthorized access to, or use of record, whether for breach of contract, tort, negligence, or under any other cause of action. Furthermore, this disclaimer applies to any damages or injury caused by any failure of performance of any product supplied by others and used in conjunction with our information whether due to product failure, stress, welding error, welding or support omission, seam or weld interruptions, item adds or deletions, or any other defect whatsoever. It should not be assumed that future results will equal past performances and we make no guarantees that you will have success... but we pray you will indeed.

*Reader agrees to assume all risk resulting from the application of any of the information provided herewith and by using any PDF or CD application, web site, including any applets, software or hard copies, and any content contained herein, the visitor agrees that the use of this information product is entirely at his or her own risk.*

## BigDaddy's Recipes for Scent Elimination

### Recipe 1

Makes 32 oz., (1 quart) – Recipe can be doubled

#### INGREDIENTS:

24 oz. Dioxidane (common 3% normal solution Hydrogen Peroxide)  
40 oz. Distilled Water  
¼ Cup Sodium Hydrogen Carbonate (common Baking Soda)  
1 oz. UNSCENTED Laundry Detergent

In a large bowl mix the distilled water and Dioxidane (Hydrogen Peroxide) together. Slowly add the Sodium Hydrogen Carbonate (Baking Soda) until dissolved. Add detergent and stir well without shaking. Using a funnel, pour the solution slowly into a clean plastic jug or container leaving the cap loose. Allow solution to stand in a cool dark place with a loose cap for 7 days. Choose dark spray bottles when ready to divide the prepared solution into smaller amounts.

Spray on clothes, gear and boots before each hunt!

### Recipe 2

Makes 48oz. (1.5 quarts) – Recipe can be doubled

#### INGREDIENTS:

16oz. Dioxidane (common 3% normal solution Hydrogen Peroxide)  
32oz. Distilled Water  
1/3 Cup Sodium Hydrogen Carbonate (common Baking Soda)  
1.5oz. UNSCENTED hunters shampoo or Pure Vegetable Glycerin

In a large bowl mix the distilled water and Dioxidane (Hydrogen Peroxide) together. Slowly add the Sodium Hydrogen Carbonate (Baking Soda) until dissolved. Add shampoo or glycerin and stir well without shaking. Using a funnel, pour the solution slowly into a clean plastic jug or container leaving the cap loose. Allow solution to stand in a cool dark place with a loose cap for 7 days. Choose dark spray bottles when ready to divide the prepared solution into smaller amounts.

Spray on clothes, gear and boots before each hunt!

### Recipe 3

Makes about 1 Gallon

#### INGREDIENTS:

3 quarts (96oz) Distilled water  
16oz. Dioxidane (common 3% normal solution Hydrogen Peroxide)  
2 Cups Sodium Hydrogen Carbonate (common Baking Soda)  
3 TBLS Hunters Scent Free Body Wash or Pure Glycerin



In a large bowl mix the distilled water and Dioxidane (Hydrogen Peroxide) together. Slowly add the Sodium Hydrogen Carbonate (Baking Soda) until dissolved. Add body wash or glycerin and stir well without shaking. Using a funnel, pour the solution slowly into a clean plastic jug or container leaving the cap loose. Allow solution to stand in a cool dark place with a loose cap for 7 days. Choose dark spray bottles when ready to divide the prepared solution into smaller amounts.

Spray on clothes, gear and boots before each hunt!

### BigDaddy's personal Cover Spray Recipe

(Great to make the day or a few days before your hunt!)

Gather about 2 lbs. of dead brush, grass, and bark from the area where you will be hunting (choose a variety of different dominant plant species in your area). Boil the gatherings in 1 Gallon distilled water, uncovered for 30 minutes.

Allow mixture to cool, strain and pour liquid into a clean spray bottle.

Before and during the hunt, spray clothes, gear and boots and go undetected!

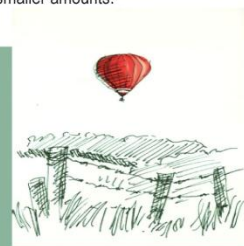

## Scent Free Soap

OK, how many bottles of scent free body wash have we all bought over the years? That liquid soap sure does not seem to last very long, and gets to be expensive after a while, especially if you have multiple hunters in the family. After spending a lot of money on this myself, I decided to look for fragrance free bar soaps, and finally I found that Dove makes one - Dove Fragrance Free Sensitive Skin Unscented Bar. Again I have used this product for over two seasons now, with great success. I have not had issues of deer scenting me due to my soap. This is an inexpensive alternative to those others manufactured specifically for hunting, and you can wash your hair with it as well, and for some reason I feel cleaner and my skin does not dry out as fast!

## Scent Free Deodorant

There are many traditional brands of scent free/fragrance free deodorants out of the market. I truly feel that all of them out perform those branded specifically to hunters as well. So, next time you are at the drugstore browse the deodorant section and you will find many brands that have these scent /fragrance free products in both gel and solids. Again I have been using them for the past couple years myself with great results.

## Scent Free Laundry Soap

Ok, I am sure most of you have heard of this one, but I use plain old backing soda! Again, I can attest that it seems to work just fine, I buy a large box of this at my local super store (Costco) and, for me, and it lasts all season long. I use it to wash all my hunting clothes in. Speaking of washing, always use cold water, and turn your camo inside out to help lengthen the life of your favorite camo garments. I have had the same set for over 5 years now, and they still look new, and work just fine. Another note about using baking soda, put it into the water first, and make sure it is dissolved before you put your clothes in, if you put it over top of your clothes, it may not dissolve, and your clothes will come out with lumps of baking soda on them, not what you want (take it from experience)!!!



## Disclaimers and Other Legal Stuff ... Again

HuntUSA.org®, HuntSports.com®, TheNationalHuntingConsortium®, ThePolak®, WeFixItUSA.com®, eSeekGod.com®, iAskGod.com®, it's owners, operators, nor any of our other world wide web venues, retailers, subsidiaries, suppliers, vendors, manufacturers, non-profits, members or any associates whatsoever, assumes any responsibility or liability, express or implied, for the use of, or misuse of, any product either bought, sold, listed, offered, or shown herein or offered thru any other sales or marketing web-site or venue. All City, County, State, and Federal Laws and Ordinances must be strictly adhered to and are the sole responsibility of the buyer. We make no warranties, expressed or implied, other than those as stated by the manufacturer. No information provided by us or sold by us shall be rented, sold, or given away to any third party business or individual without the copyright owner permissions. We will never willfully disclose any information about our site visitors without first receiving the visitor's permission to do so. Any Do-It-Yourself, or Handyman Guides are designed to help you and there are no warranties, either express or implied and your results will differ from others, based on knowledge and skill levels. The fundamental concept of this information provided herewith is that you read, study and possibly utilize this product as a "starting point" for going forward with planning your project; If you need to perform independent research, then do so and judge for yourself the merits of the material that has been provided herewith.

**BigDaddy@HuntSports.com** recommends and endorses specific ideas, concepts and opportunities and cannot be liable for same. You should carefully consider whether our plans, ideas, concepts, How To and DIY programs or information is appropriate for you personally, in light of your experience, objectives, financial resources and other personal circumstances. The websites and all information technology and information provided herein are for guidance and information purposes only and their content for products and services offered are not intended to provide investment, tax, business development or other legal advice. The information contained herein has been compiled from sources deemed reliable and accurate to the best of our knowledge. However, we cannot guarantee the accuracy, completeness and cannot be held liable for any errors or omissions. Changes may be made periodically and at any time. We herewith deny any responsibility to update any previously purchased PDF's or copies of CD's etc.

All information contained herein should be independently verified and confirmed by appropriate sources and we do not accept any liability for any loss or damages whatsoever and the reader, or user, herewith agrees to indemnify and hold us harmless for any damages, costs or expenses, including any legal fees, potentially resulting from the application of any of the information provided herewith. This disclaimer applies to any damages or injury caused by any failure of performance, error, omission, interruption, deletion, defect, delay in operation or transmission, computer virus, communication line failure, theft or destruction or unauthorized access to, or use of record, whether for breach of contract, tort, negligence, or under any other cause of action. Furthermore, this disclaimer applies to any damages or injury caused by any failure of performance of any product supplied by others and used in conjunction with our information whether due to product failure, stress, welding error, welding or support omission, seam or weld interruptions, item adds or deletions, or any other defect whatsoever. It should not be assumed that future results will equal past performances and we make no guarantees that you will have success... but we pray you will indeed.

*Reader agrees to assume all risk resulting from the application of any of the information provided herewith and by using any PDF or CD application, web site, including any applets, software or hard copies, and any content contained herein, the visitor agrees that the use of this information product is entirely at his or her own risk.*



**HuntSports 2014 Product Showcase**

# HuntSports Bowhunting Products

## Tree Stands & Accessories

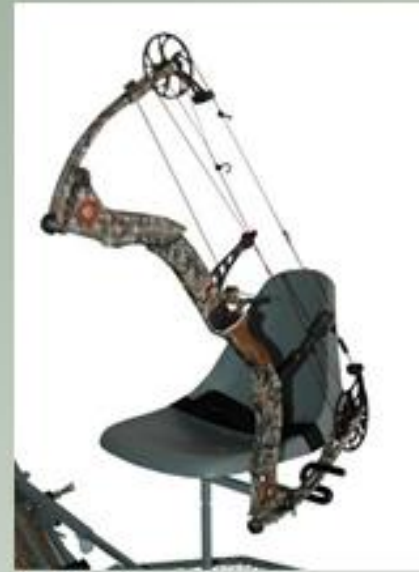

Click [Here](#) for a Full Selection of Our Latest Bowhunting Products and Accessories.

**LIKE US ON FACEBOOK AND TWITTER** and save up to  
**50% OFF** Any of BigDaddy's Build-Your-Own Plans



# HuntSports Bowhunter Food Plot Products



Click [HERE](#) to see Our Full Selection of Food Plot Seeds, Mineral Supplements, ATV Tillers and More.



# HuntSports Deer Blind Product Update



Click [HERE](#) to See Our Full Selection of Deer Blinds and Towers

**LIKE US ON FACEBOOK AND TWITTER** and save up to **50% OFF** any of BigDaddy's Build-Your-Own Plans



# HuntSports Deer Blind Product Update



Click [HERE](#) to See Our Full Selection of Deer Blinds and Towers

**LIKE US ON FACEBOOK AND TWITTER** and save up to 50% OFF any of BigDaddy's Build-Your-Own Plans



# BigDaddy's Build-Your-Own Deer Blind Plans

## 2013 Camper Conversion



## After



**LIKE US ON FACEBOOK AND TWITTER** and save up to **50% OFF** any of BigDaddy's Build-Your-Own Plans



# HuntSports Deer Feeder Parts



Watertight Lid for the top of the drum



Galvanized Steel Lid

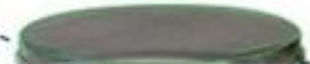

Polyethylene Lid



55 Gallon Barrel

## Feeder Parts



Polyethylene Funnel

Funnel fits tightly into the bottom of the drum



Spun Steel Funnel



Barrel band leg kit for mounting legs



Barrel Band



Feed dispenser units



Automatic Feeder Control



Gravity Feeder Unit

**LIKE US ON FACEBOOK AND TWITTER and save up to 50% OFF any of BigDaddy's Build-Your-Own Plans**



# HuntSports Deer Feeder Updates

## IR Hog Light Wildlife Feeders



Click [HERE](#) to see our Full Selection of IR Feederlights



# HuntSports Infrared Hog and Feeder Lights



LIKE US ON FACEBOOK AND [TWITTER](#) and save up to 50% Off any of BigDaddy's Build Your Own Plans



# HuntSports Hog Light Kits

## Hog Hunting Light Kits



Remotes



Dusk / Dawn Sensors



Night Vision Scopes



Infrared Lights

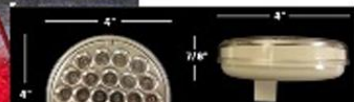

Click [Here](#) to Visit [HuntSports.com](#) to See Our Selection of DIY Hog Light Kits.



# HuntSports Hog Light Components



**Dusk to Dawn Sensors**



**Power Supplies**



**Remote Control Units**



**Super Bright LED's  
Available in Multiple Colors**

**Looking to Build Multiple Units?  
E-Mail [BigDaddy@HuntSports](mailto:BigDaddy@HuntSports) and ask about Package Deals**



You Tube



Click [Here](#) to Visit HuntSports YouTube Channel

**Subscribe** and save up to 50% off Any of  
**BigDaddy's Build-Your-Own Plans**

# DIGISIGHT

MODELS | Copyright © 2010

# Hunt Sports

.COM

We're ALL Your Hunting Needs™

# NW DIGITAL



## 1 MAIN MENU

The Digisight main menu includes brightness control of the reticle, choice of the reticle shapes as well as setting of ranging time.

## 2 WINDAGE/ELEVATION KNOB

Reticle adjustment (movement of the reticle horizontally and vertically during sighting) is performed by a special knob. Switching from the horizontal movement mode to the vertical and vice versa is performed by pressing a button located right on the knob.

## 3 WEAVER 7/8"

Half Weaver on the left side of the body is used for attaching additional accessories.

## 4 Mini-USB

The mini-USB port allows the riflescope to be connected to a personal computer or a laptop to upload additional (including user-constructed) aiming reticles.

## 5 QUICK IMAGE ADJUSTMENT

A group of functions including **Control mode** (for a sharp contrast increase), **Color mode** (successive change of LCD display's illumination color) and **SunLight mode** (enhances sensitivity enhancement algorithm) are available.

## 6 VIDEO IN / VIDEO OUT

The Digisight N100 is equipped with a socket for connection of external video recording sources or video playback sources. Switching from VIDEO IN mode to VIDEO OUT is performed by pressing a button located near to the socket.

## 7 EXTERNAL CONTROL

The Digisight N100 can be operated with the help of a remote control which replicates activation functions of the riflescope. IR illuminator and reticle inversion (see point 11). The riflescope can be powered both with 4 AA batteries, as well as with external power sources.

## 8 INTERNAL FOCUSING

The optical system employs an internal focusing mechanism (focus is controlled) with variable-click stop focus positions. The focusing provides clear images at extremely short distances as well as optimum quality at all distances within the riflescope's working range.

## 9 BRIGHTNESS ADJUSTMENT WHEEL

adjusts optimum brightness of screen's glow for each specific case.

## 10 BUILT-IN IR ILLUMINATOR

is recommended for usage at insufficient levels of natural illumination for improvement of observation quality.

## 11 RETICLE INVERSION

The inversion button allows changing color of the aiming reticle from black to white. The choice of reticle color is subject to the target's brightness.

## 12 SCREEN

The choice of one of the four operating modes (back screen, aiming reticle mode, «Clock» mode, aiming reticle & Clock mode).

## 13 LENS CAP

The riflescope's lens is covered with a plastic cap. The lens cap is fixed on the scope's body for better lens protection.

## 14 POWERING UP

the unit and the built-in IR illuminator is carried out successfully by gradual turning of the selector switch.



# HuntSports NVRS/IR Riflescopes



Click [Here](#) to View Our Full Selection of Night Vision Equipment



# Build Your Own Blinds



## Build Your Own

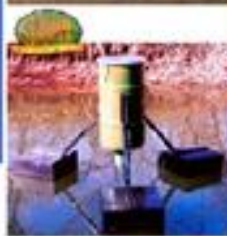

Build Your Own



# Build Your Own Blinds

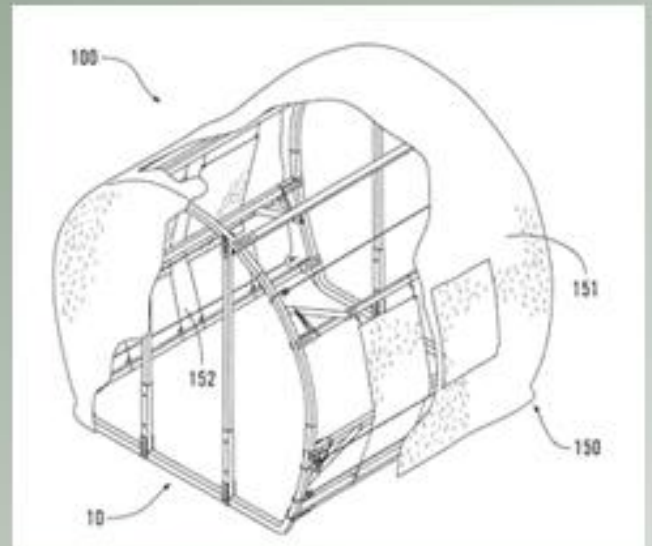

LIKE US ON FACEBOOK AND TWITTER and receive up to 50% OFF any of BigDaddy's Build-Your-Own Plans



# Customer ... Model 2014



**LIKE US ON FACEBOOK AND TWITTER and save up to 50% OFF any of BigDaddy's Build-Your-Own Plans**





## Deer Blind Windows



## DIY Plans

.. and more

## Deer Blind Windows



Plans, Kits, Aluminum and Wood  
By-Pass Sliders & More



# Deer Blind Windows

## DeerBlind



## WINDOWS

## Deer Stand Packages



**LIKE US ON FACEBOOK AND TWITTER** and receive up to 50%  
**OFF** any of BigDaddy's Build-Your-Own Plans

# Deer / Wildlife / Fish - Feeder Ideas



**Barrel Band**

**Lid**

**Barrel Funnel**

**Varmint Cage**

**12V Control**

**Battery**

**Solar Panel**

**Lake Pond River**

**Build Your Own FLOATING Fish Feeder**

**Hunt Sports**  
DEAL ALL Your Hunting Needs

**LIKE US ON FACEBOOK AND TWITTER and receive up to 50% OFF any of BigDaddy's Build-Your-Own Plans**



# DROP TUBE ... Directional Throw



**Feeder Parts**  
**Barrel Bands**  
**55 Gallon Kits**  
**Protein**  
**Free Choice**

**Soybean**

**CORN**



**Crank-Up**  
**Winch-Up**  
**Feeder Parts Kits**

**LIKE US ON FACEBOOK AND TWITTER and save up to 50% OFF any of BigDaddy's Build-Your-Own Plans**

# HuntSports Feeder-Light Ideas & Kits



## HogLights



## 12V Remote

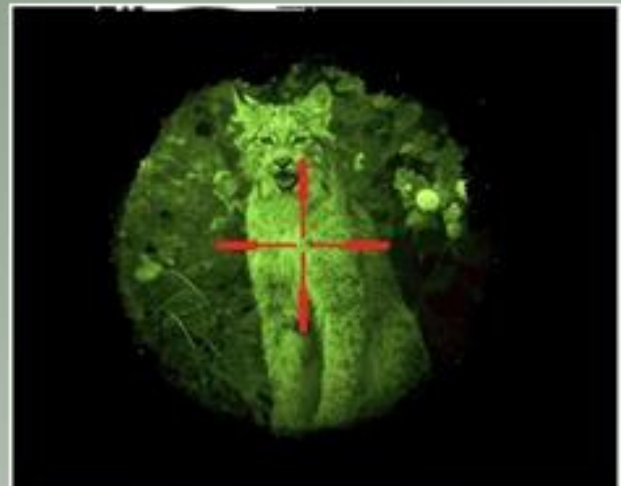

**LIKE US ON FACEBOOK AND TWITTER** and save up to **50% OFF** any of BigDaddy's Build-Your-Own Plans



# HuntSports Thermal Imaging



**LIKE US ON FACEBOOK AND TWITTER** and receive up to **50% OFF** any of BigDaddy's Build-Your-Own Plans

